



Documentation folder

Number **TC6604-1**

Project number 403978

Page 1 of 1

Description	Drawing number	Rev.	Remarks
AD-4405 External view	D304893	--	
AD-4406 External view	D304894	--	
AD-4407 External view	D304895	--	
AD-4405 Exploded view	EV AD-4405	--	
AD-4406 Exploded view	EV AD-4406	--	
AD-4407 Exploded view	EV AD-4407	--	
AD-4405 Sealing wire	SW AD-4405	--	
AD-4406 Sealing wire	SW AD-4406	--	
AD-4407 Sealing wire	SW AD-4407	--	
Block diagram AD-4405	BD AD-4405	--	
Block diagram AD-4406	BD AD-4406	--	
Block diagram AD-4407	BD AD-4407	--	
Main board AD-4405, PC3874	7PZ+3874A	--	3 pages including parts list
Main board AD-4406, PC3875	7PZ+3875	--	3 pages including parts list
Main board AD-4407 PZ3874	7PZ+3874B	--	3 pages including parts list
Power filter board (AD-4405 and AD-4407)	PC3415A	A	

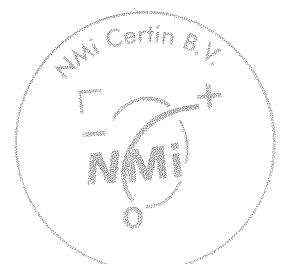

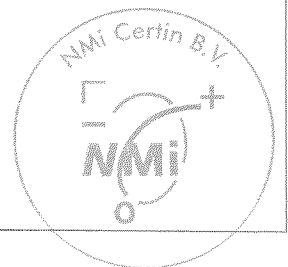
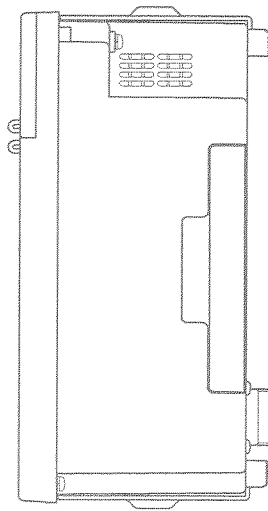
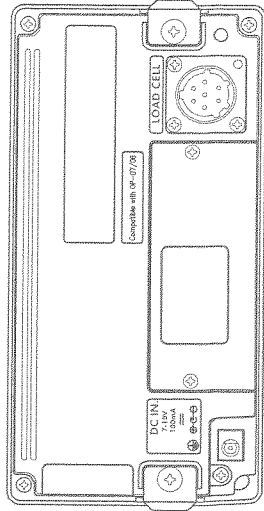
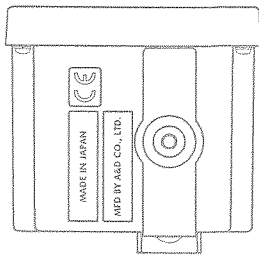
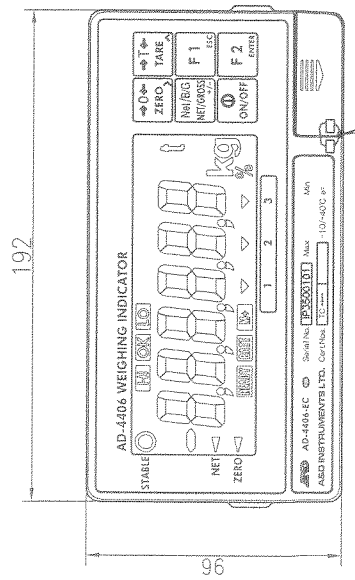
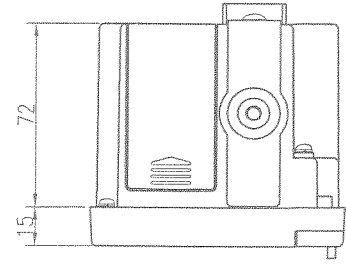
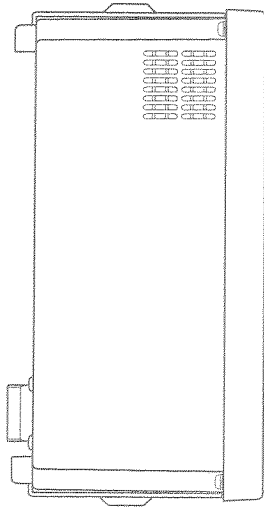

1/2		A&D CO., LTD.		AD4406	
尺 寸	公 産	材 質	部 品 表	製 理	機 種 名
製 図	設 計	検 査	承 認	入 庫	外 観 図 (EC)
					型 番
					D304894
					適 用 ロ ッ ト
記 号	月 日	組 立	改 進 No.		
設 置					

A&D CO., LTD.

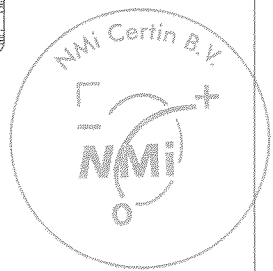
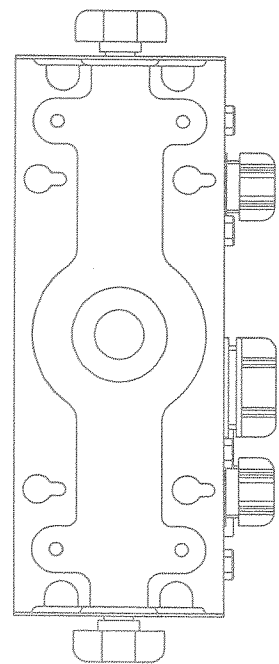
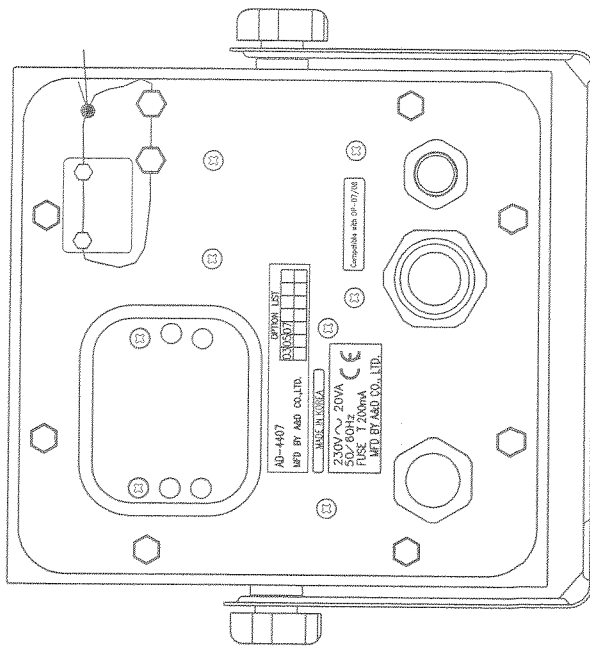
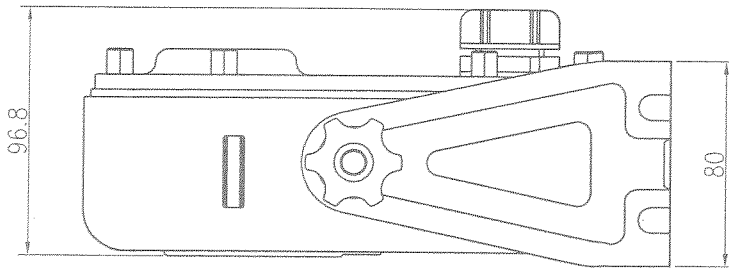
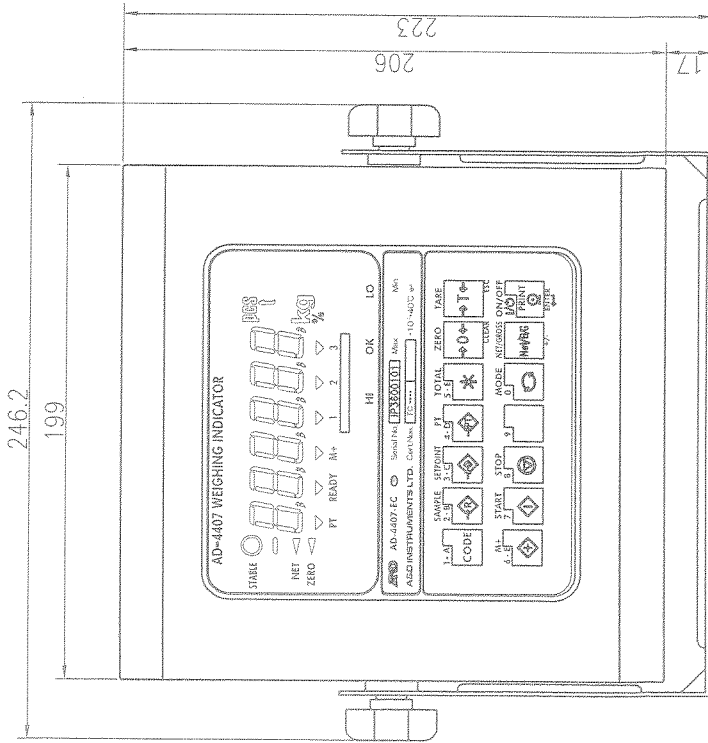

機種名	AD4407
部品表	
処理	
入庫	
名称	外觀図 (EC)
入庫No	
國番	D304895
適用ロット	
設置	
記号	
月	
日	
担当	
故障No.	

A&D CO., LTD.

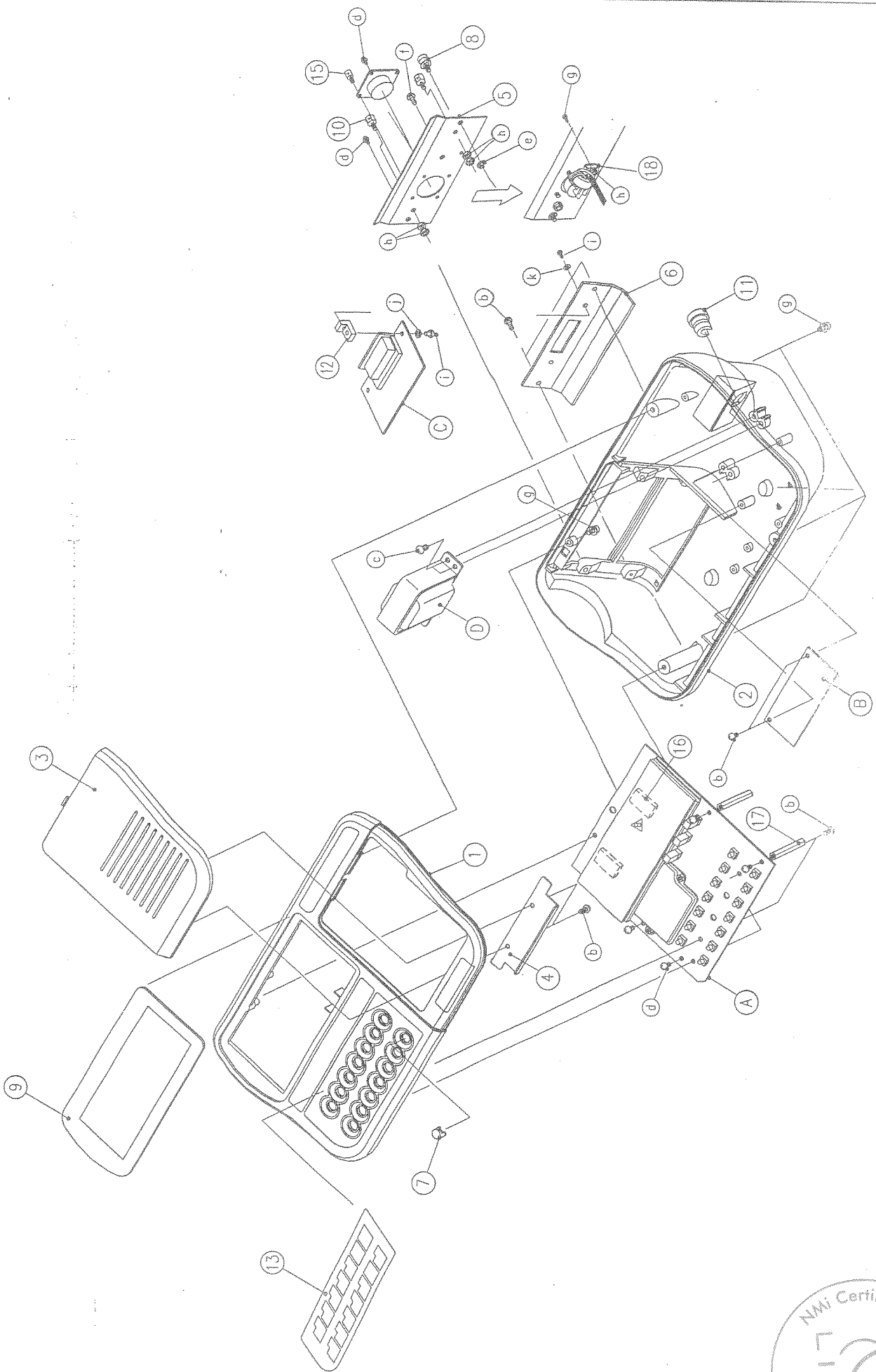

MODEL	AD-4405
DESCRIPTION	EXPLODED VIEW
STOCK No.	EV AD-4405

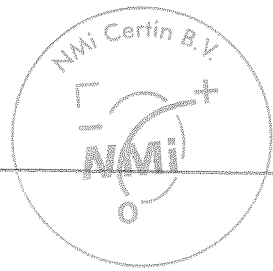

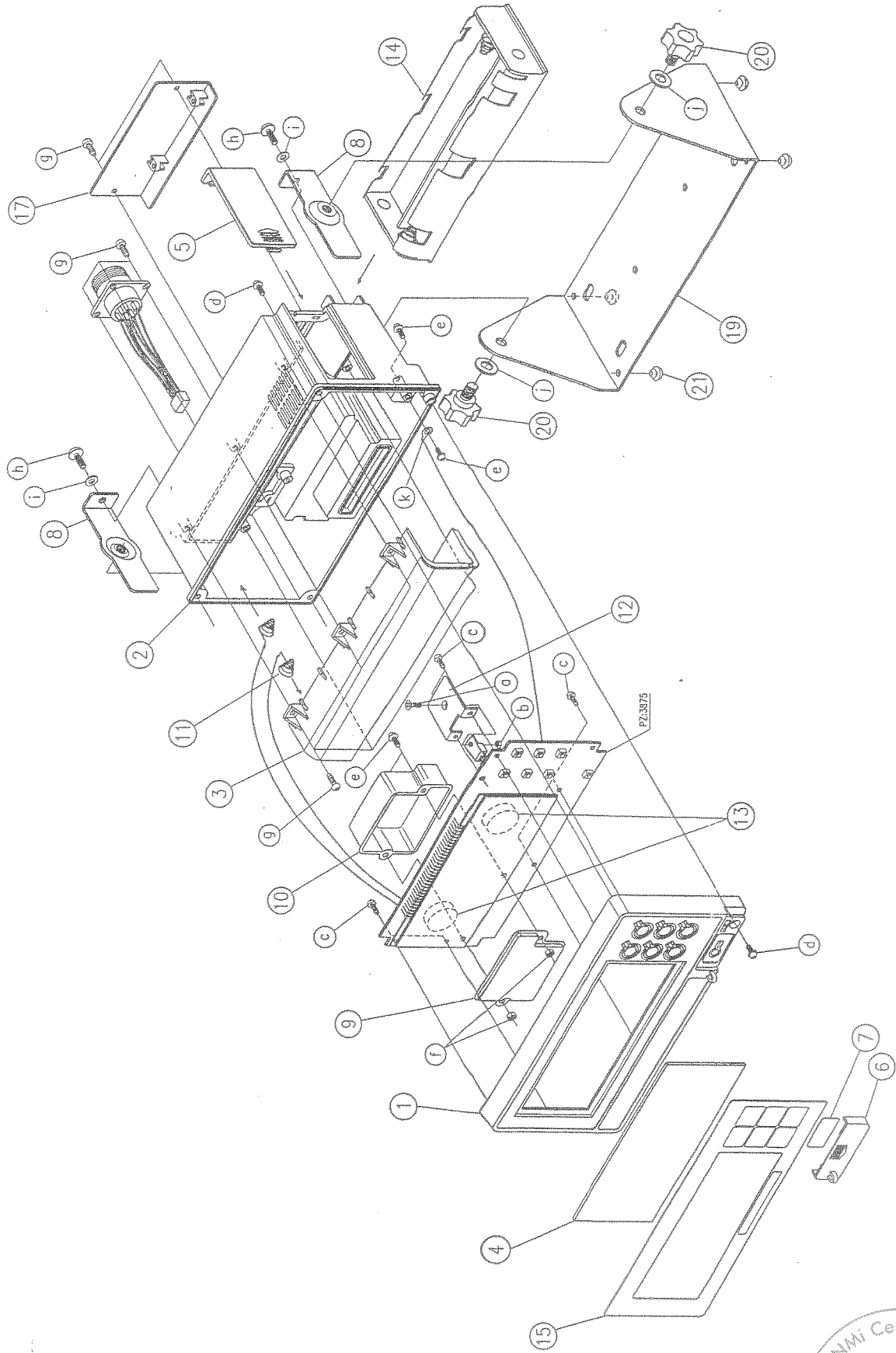

MODEL	AD-4406
DESCRIPTION	EXPLODED VIEW
STOCK No.	EV AD-4406

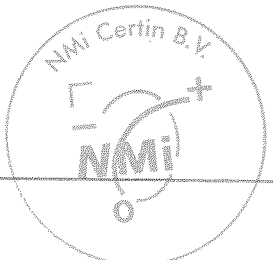

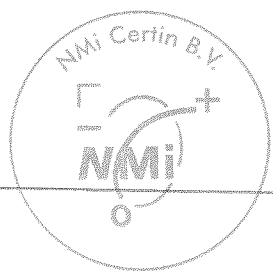
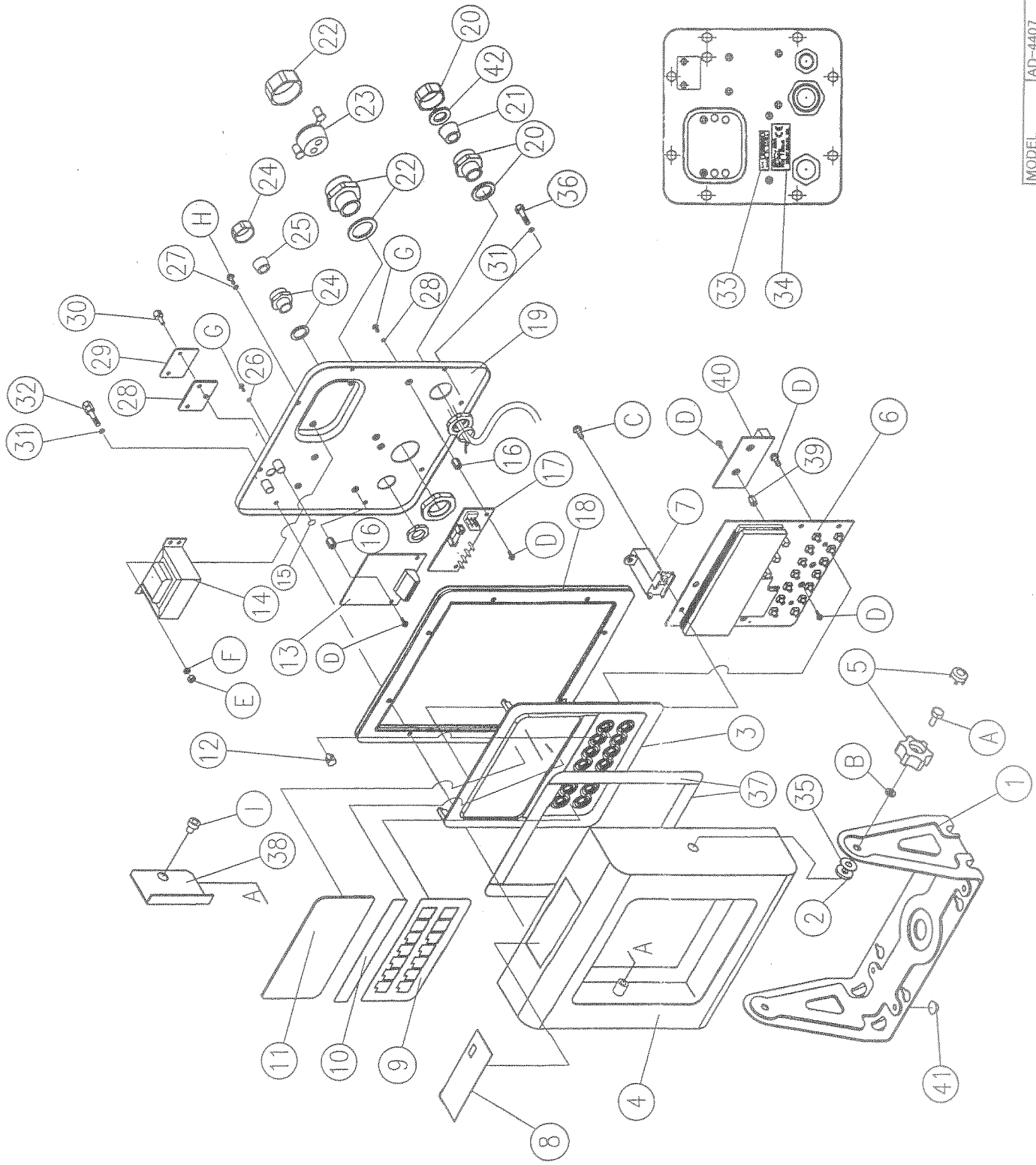

REAR VIEW

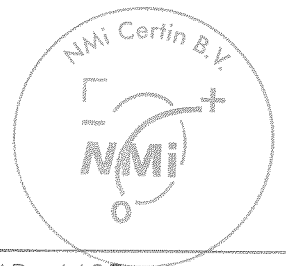
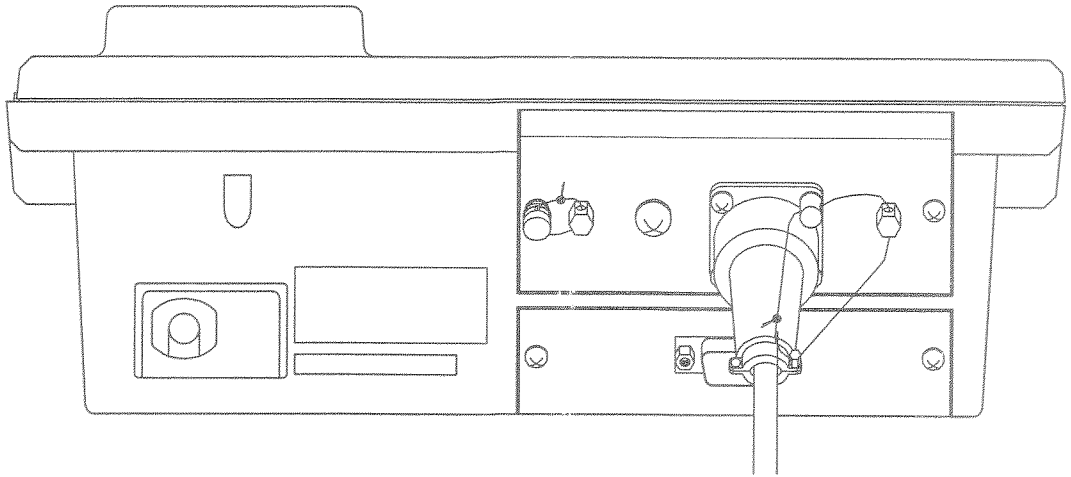

MODEL	AD-4405
DESCRIPTION	SEALING WIRE
DRAWING No.	SW AD-4405

【 FRONT VIEW 】

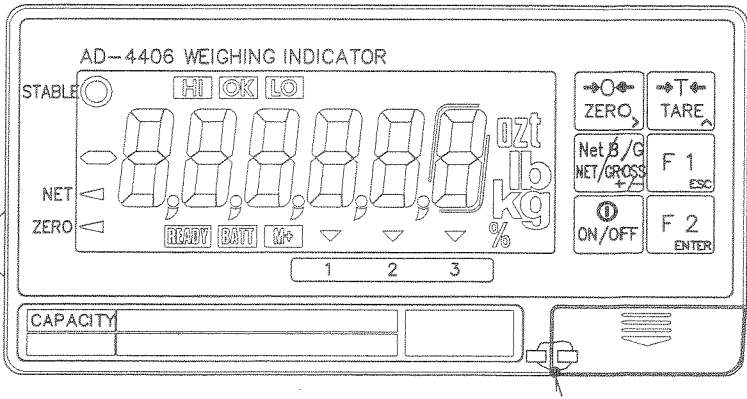

【 Enlargement 】

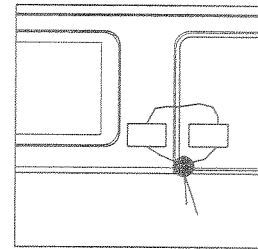

【 REAR VIEW 】

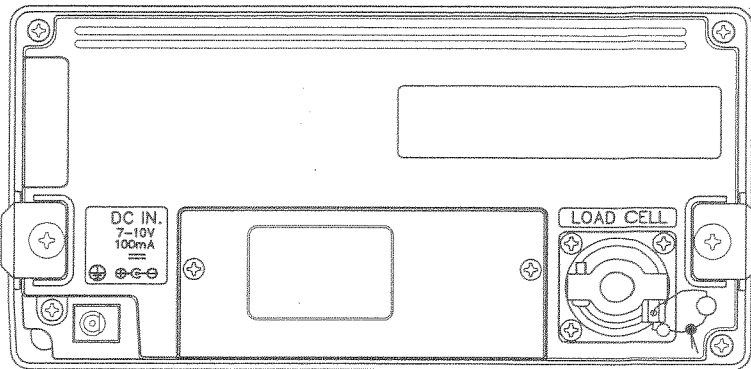

【 SIDE VIEW 】

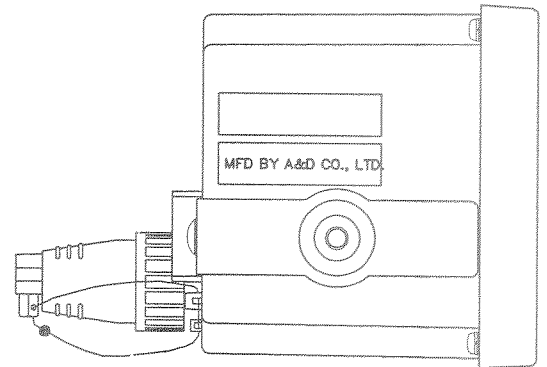

【 BOTTOM VIEW 】

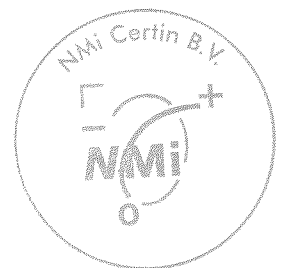
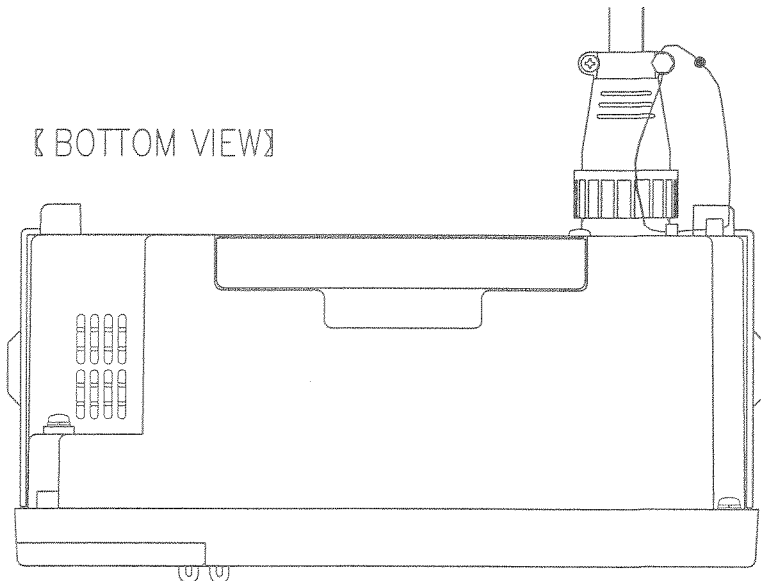

MODEL	AD-4406
DESCRIPTION	SEALING WIRE
DRAWING No.	SW AD-4406

【 Enlargement 】

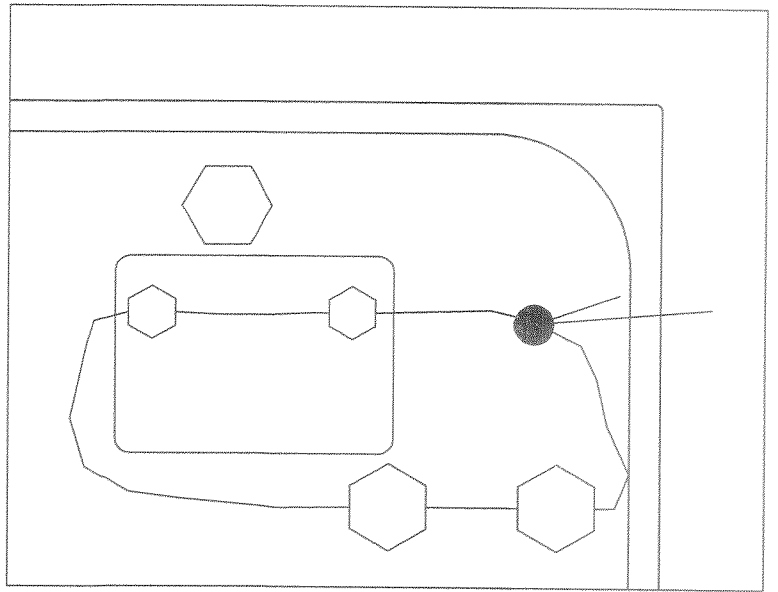

【 REAR VIEW 】

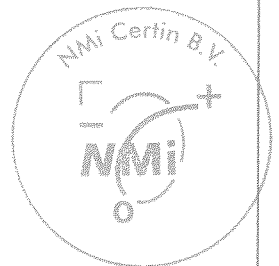
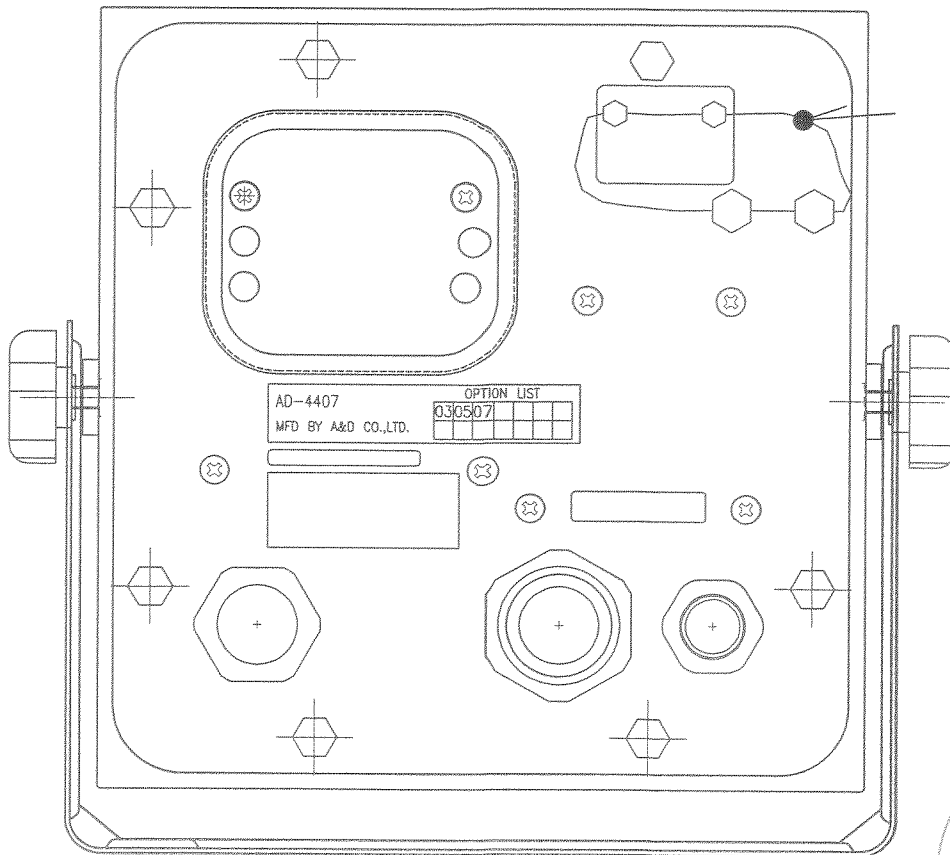

MODEL	AD-4407
DESCRIPTION	SEALING WIRE
DRAWING No.	SW AD4407

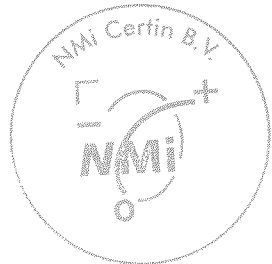
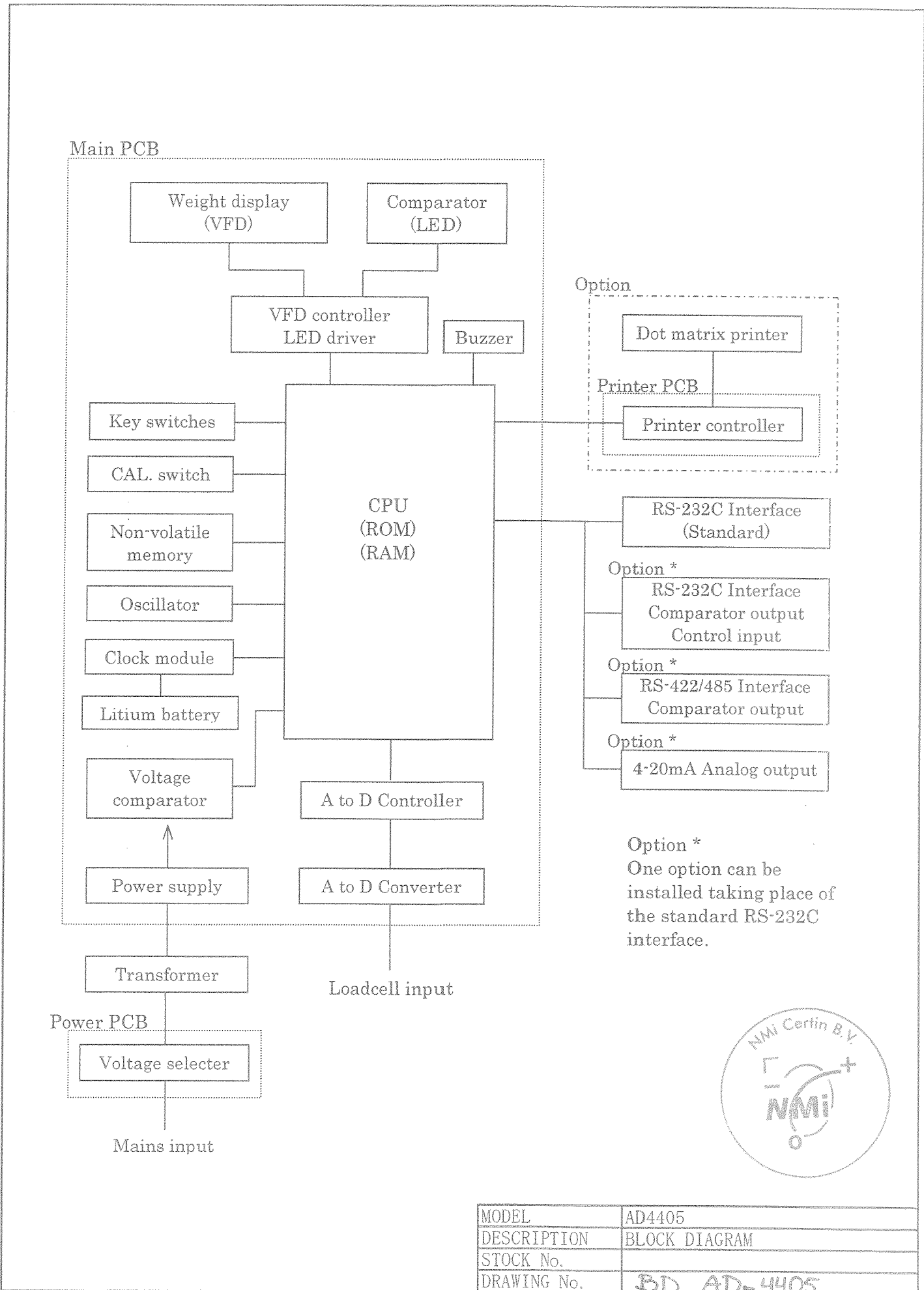

MODEL	AD4405
DESCRIPTION	BLOCK DIAGRAM
STOCK No.	
DRAWING No.	BD AD-4405

Main PCB

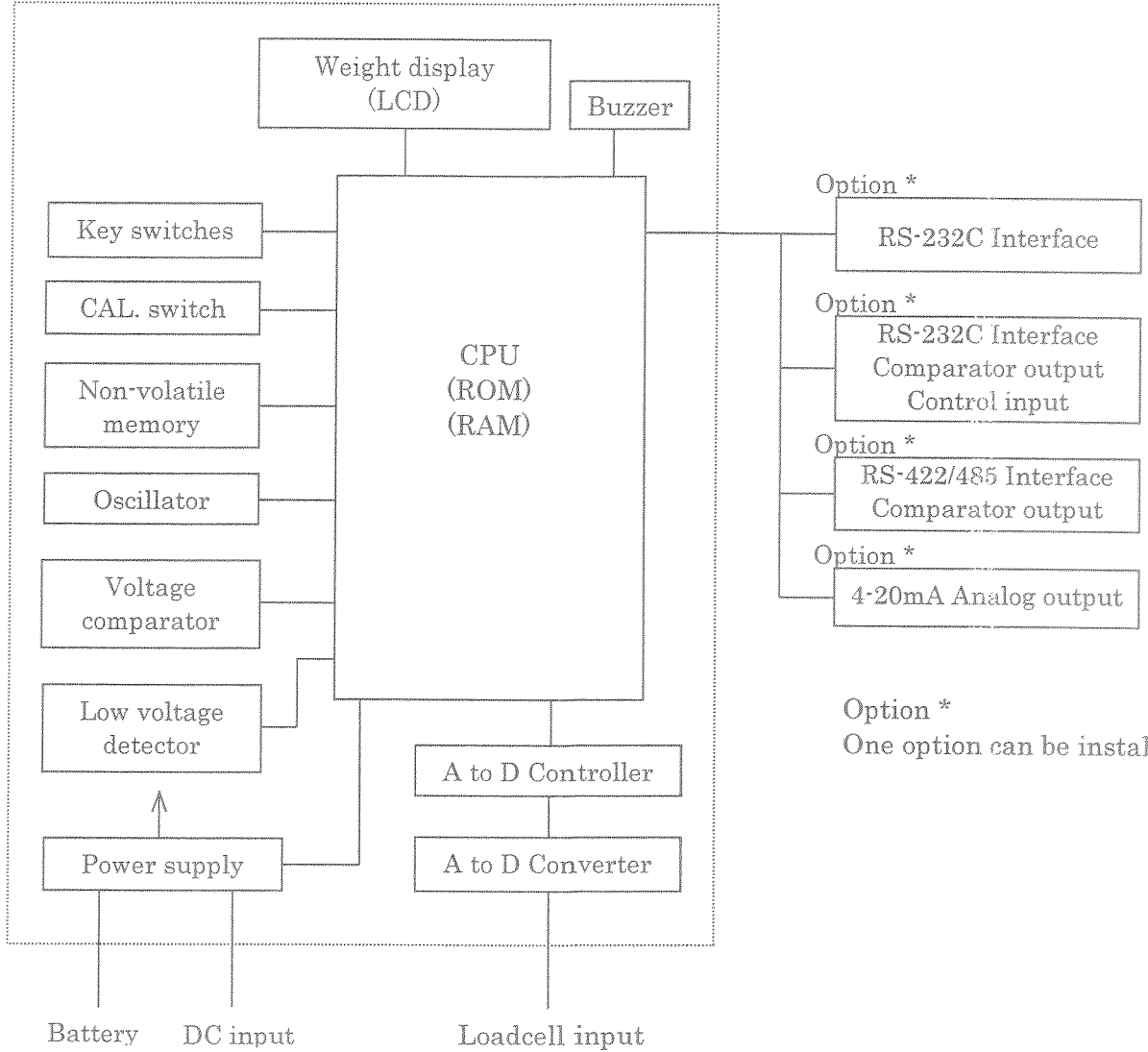

Option *
One option can be installed.

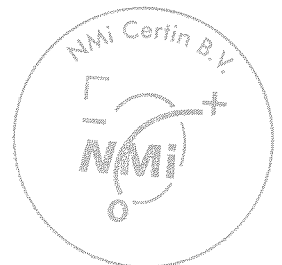

MODEL	AD4406
DESCRIPTION	BLOCK DIAGRAM
STOCK No.	
DRAWING No.	13D AD-4406

Main PCB

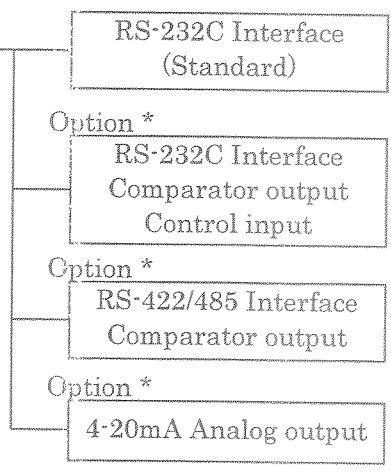
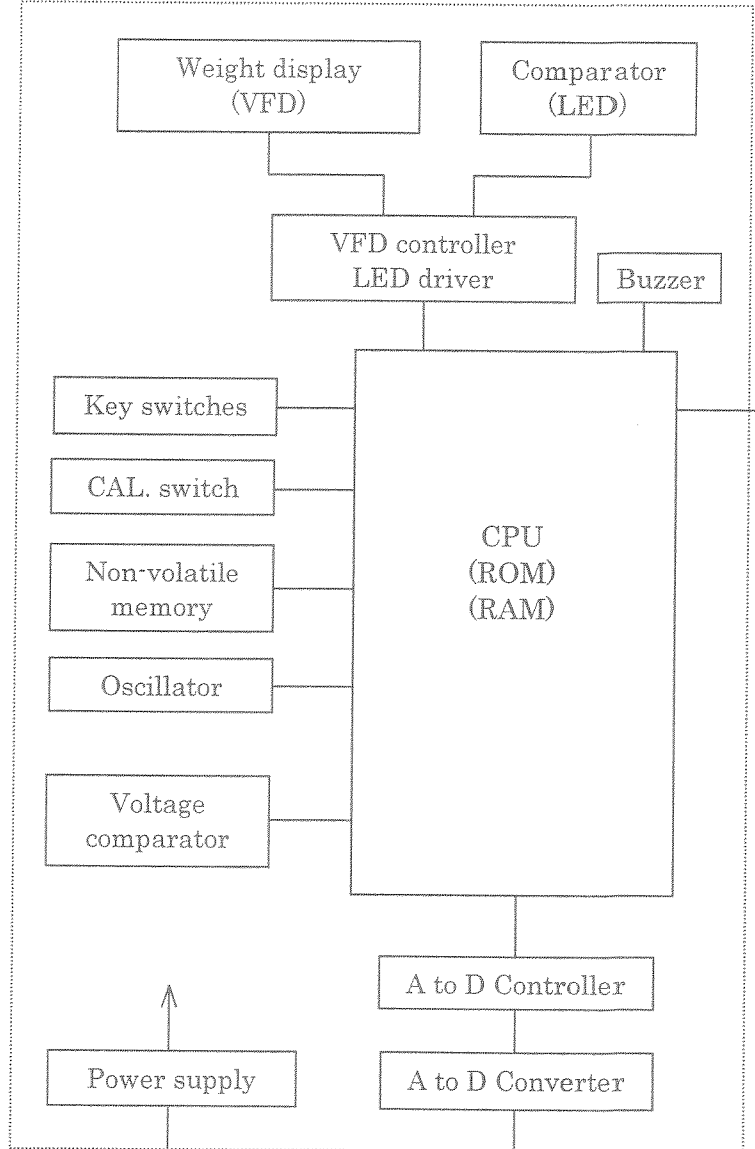

Option *
One option can be installed taking place of the standard RS-232C interface.

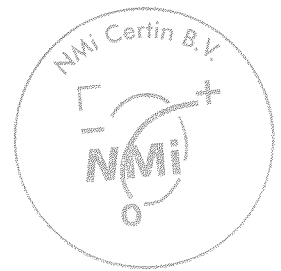
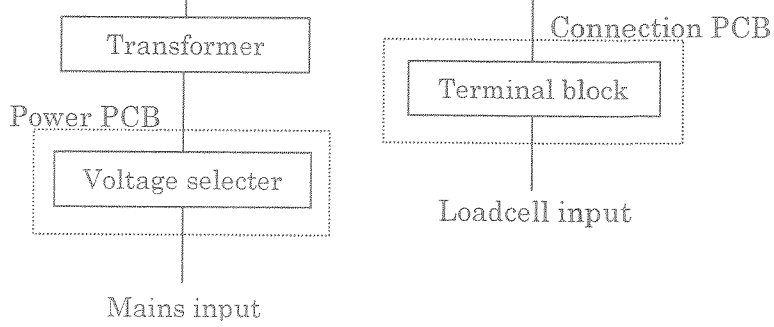

MODEL	AD4407
DESCRIPTION	BLOCK DIAGRAM
STOCK No.	
DRAWING No.	BD AD-4407

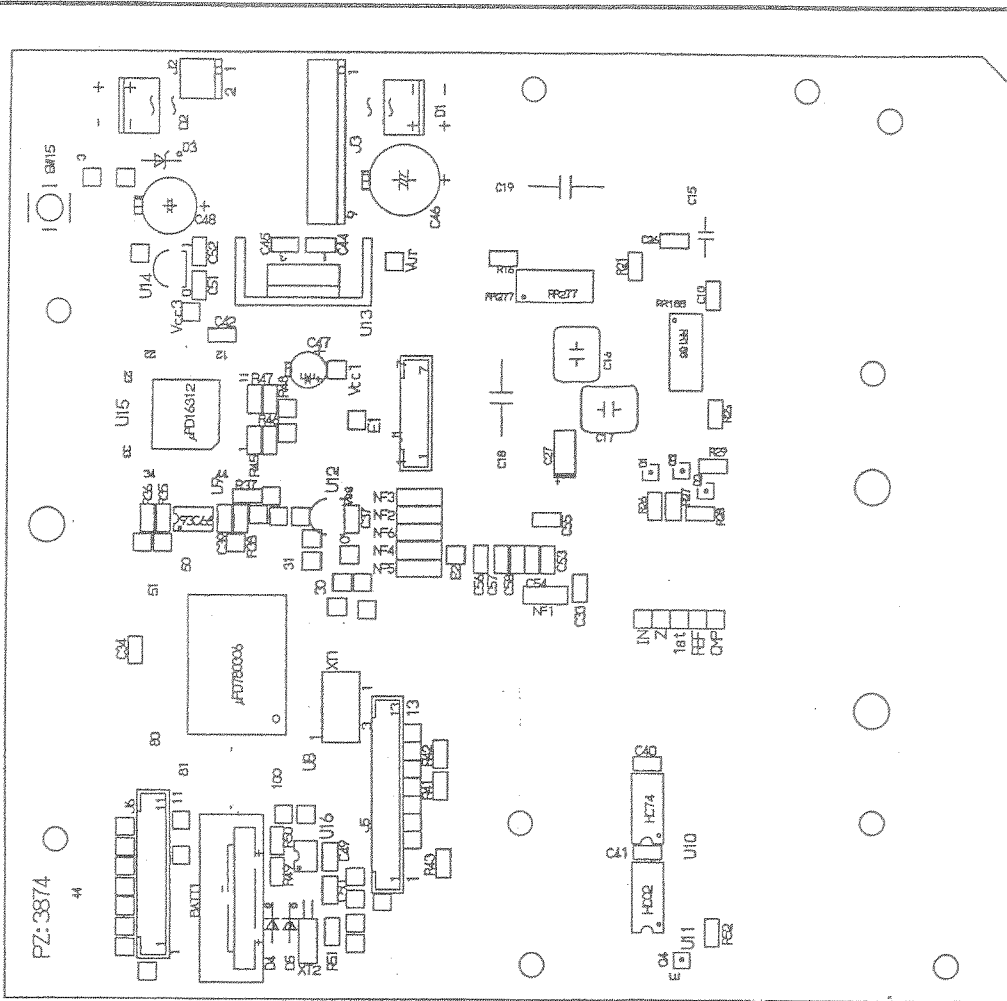
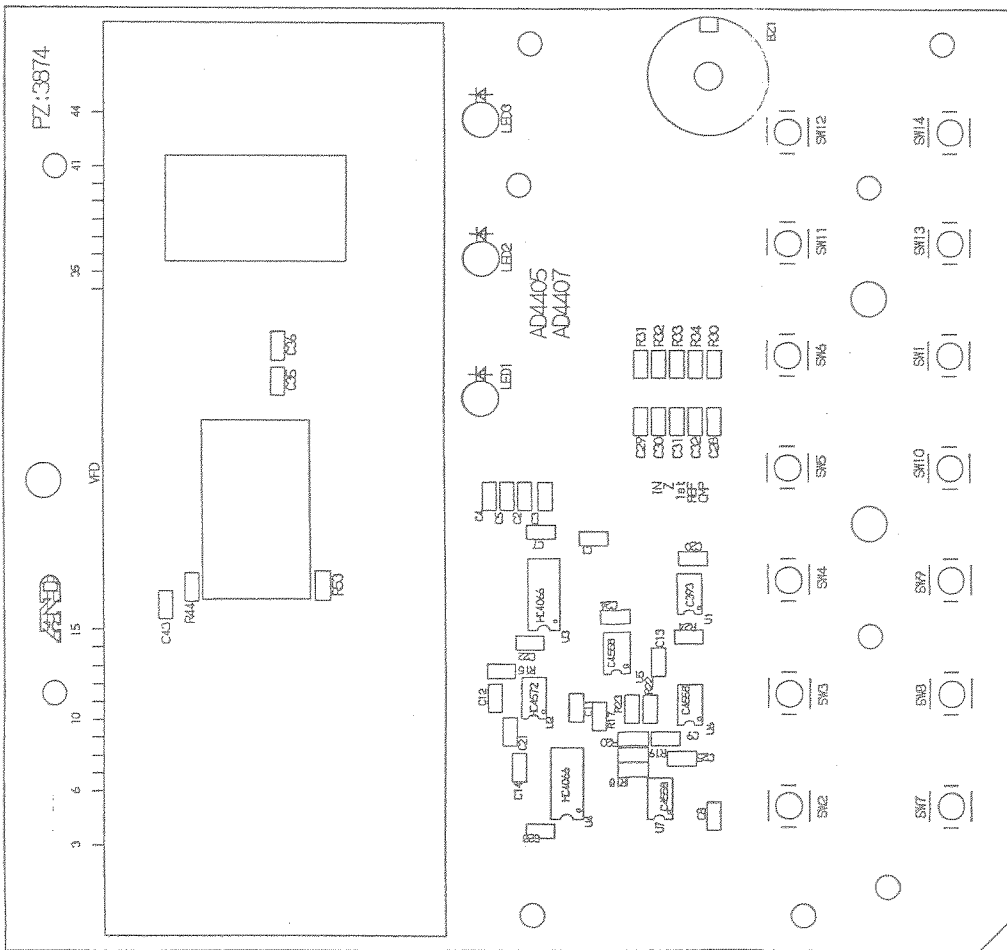

MODEL	AD-4405
DESCRIPTION	MAIN BOARD
STOCK No.	7PZ*3874A
DRWG.No.	1/3

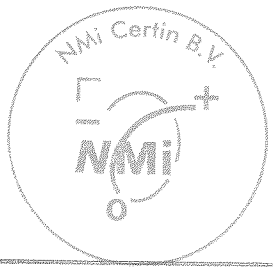

7PZ+3874A PARTS LIST

2/3

Circuit Symbol	Part No.	Description	Quantity
	PC+3874D	PRINTED WIRING BOARD	1
BZ1	ET+EFB-AA40D101	BUZZER	1
C1-5	CC+0.1U25V-C	CERAMIC CAPACITOR	5
C6		(not installed)	
C7	CC+0.1U25V-C	CERAMIC CAPACITOR	1
C8	CC+220P-C	CERAMIC CAPACITOR	1
C9,10	CC+0.1U25V-C	CERAMIC CAPACITOR	2
C11-14	CC+3P-C	CERAMIC CAPACITOR	4
C15	CP+P1H104JZ	POLYPROPYLENE FILM CAPACITOR	1
C16	CM+V1H224JZT	POLYESTER FILM CAPACITOR	1
C17	CM+V1H474JZT	POLYESTER FILM CAPACITOR	1
C18,19	CP+ECQP1474JZW	POLYPROPYLENE FILM CAPACITOR	2
C20	CC+0.1U25V-C	CERAMIC CAPACITOR	1
C21-23	CC+0.001U-C	CERAMIC CAPACITOR	3
C24-26	CC+0.1U25V-C	CERAMIC CAPACITOR	3
C27	CT+1V010-C	TANTALUM CAPACITOR	1
C28-32	CC+100P-C	CERAMIC CAPACITOR	5
C33-37	CC+0.1U25V-C	CERAMIC CAPACITOR	4
C38		(not installed)	
C39-45	CC+0.1U25V-C	CERAMIC CAPACITOR	7
C46	CK+SME35VB1000	ALUMINIUM ELECTROLYTIC CAPACITOR	1
C47	CK+SME16VB33	ALUMINIUM ELECTROLYTIC CAPACITOR	1
C48	CK+SME63VB100	ALUMINIUM ELECTROLYTIC CAPACITOR	1
C49	CC+0.1U25V-C	CERAMIC CAPACITOR	1
C50	CC+5P-C	CERAMIC CAPACITOR	1
C51,52	CC+0.1U25V-C	CERAMIC CAPACITOR	2
C53-58	CC+0.001U-C	CERAMIC CAPACITOR	6
D1,2	DI+1B4B42	BRIDGE DIODE	2
D3	DZ+05Z6.8	ZENER DIODE	1
D4	DI+1SS97	SCHOTTKY BARRIER DIODE	1
D5	DI+1SS53	SCHOTTKY BARRIER DIODE	1
D6		(not installed)	
EB1	EB+CR2032-WT12	LITHIUM BATTERY	1
J1	J1+7P-S2T2-EF	CONNECTOR	1
J2	J1+2P-S3T2-E	CONNECTOR	1
J3	JT+171825-9	CONNECTOR	1
J4		(not installed)	
J5	J1+13P-S2T2-EF	CONNECTOR	1
J6	J1+11P-S2T2-EF	CONNECTOR	1
LED1	DL+GL8HD22	LED(RED)	1
LED2	DL+GL8EG22	LED(GREEN)	1
LED3	DL+GL8HD22	LED(RED)	1
NF1-6	NF+EXCCET102U	EMC FILTER	6
Q1-3	QT+FA1L4M-C	NPN TRANSISTOR	3
Q4	QT+FB1L3N-L	NPN TRANSISTOR	1
R1-8	RF+RR277	NETWORK RESISTOR	1
R9-14	RF+RR188A	NETWORK RESISTOR	1
R15,16	RC+1/10W393J	RESISTOR	2
R17	RC+1/10W332J	RESISTOR	1
R18	RC+1/10W822J	RESISTOR	1
R19	RC+1/10W332J	RESISTOR	1
R20	RC+1/10W222J	RESISTOR	1
R21	RC+1/10W102J	RESISTOR	1
R22	RC+1/10W104J	RESISTOR	1
R23	RF+2D4.22KRF	RESISTOR(25PPM/C)	1
R24	RF+2D11.5KQA	RESISTOR(10PPM/C)	1
R25	RC+1/10W104J	RESISTOR	1
R26,27	RC+1/10W332J	RESISTOR	2
R28,29	RC+1/10W393J	RESISTOR	2
R30-34	RC+1/10W101J	RESISTOR	5

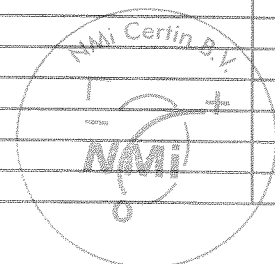

MODEL	AD-4406
DESCRIPTION	MAIN BOARD
STOCK No.	7PZ-3875
DRWG.No.	1/3

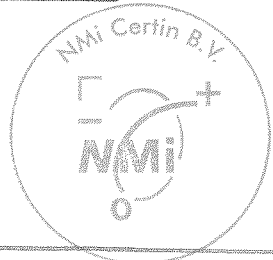
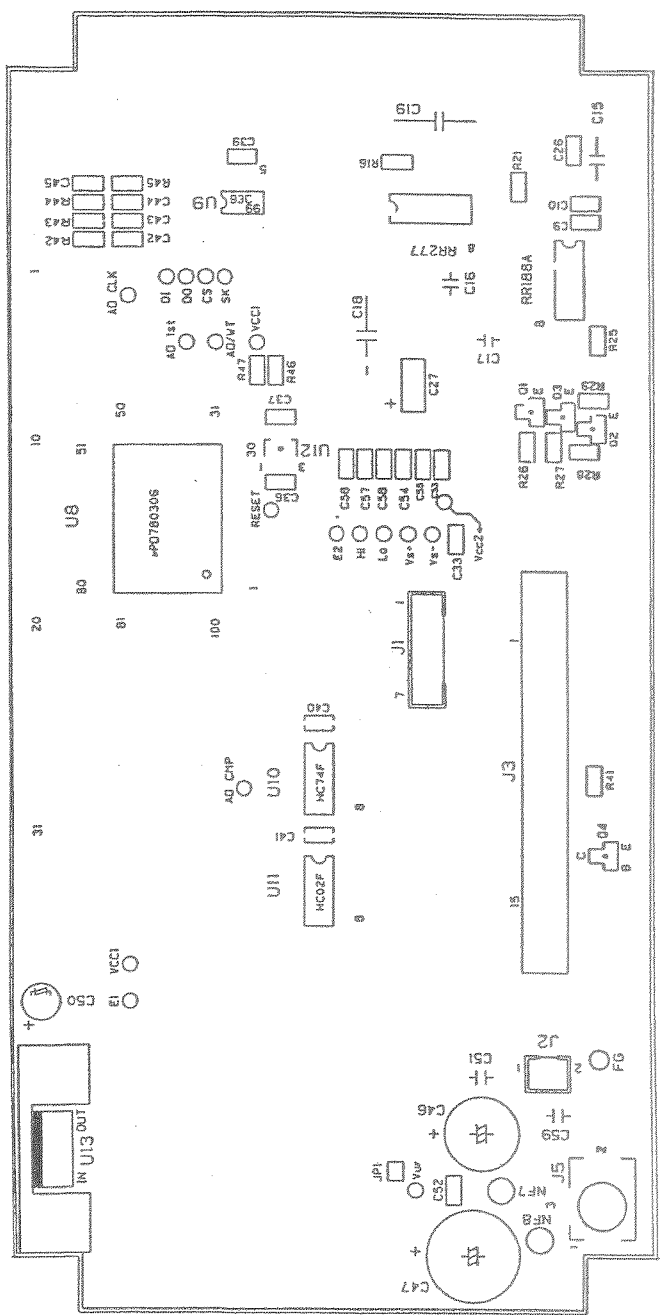
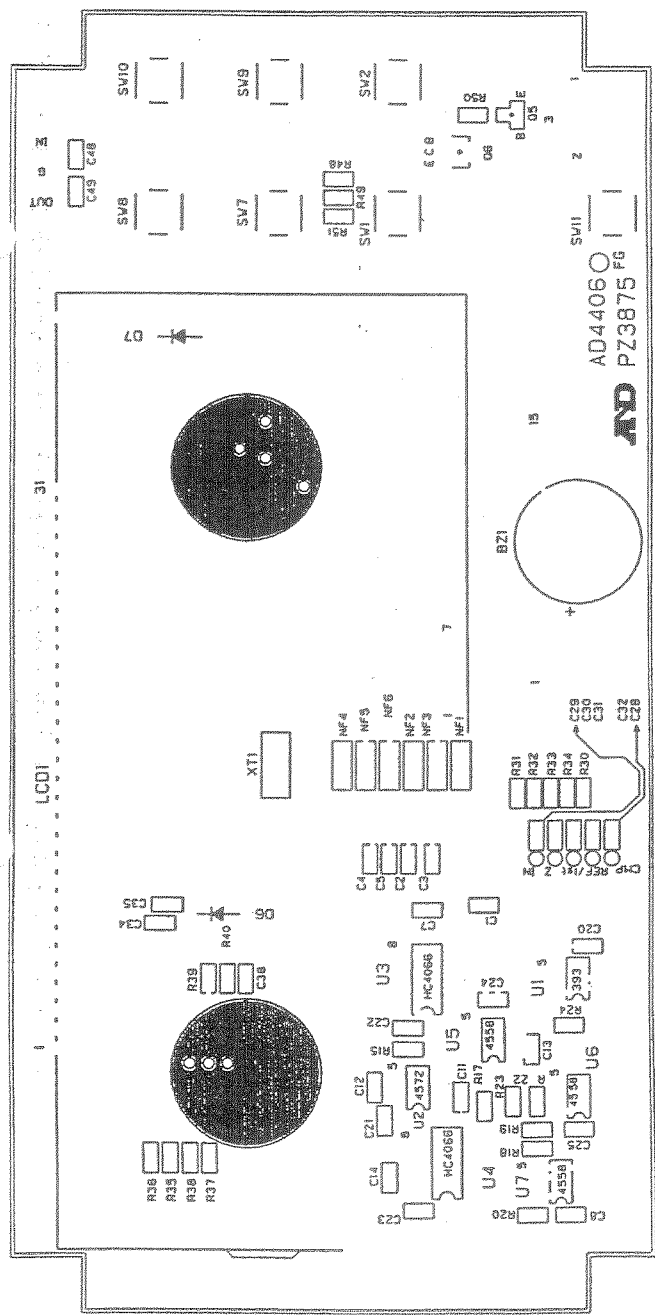

7PZ+3875 PARTS LIST

2/3

Circuit Symbol	Part No.	Part Name	Quantity
	PC+3875E	PRINTED WIRING BOARD	1
BZ1	ET+EFB-AA40D101	BUZZER	1
C1-5	CC+0.1U25V-C	CERAMIC CAPACITOR	5
C6		(not installed)	
C7	CC+0.1U25V-C	CERAMIC CAPACITOR	1
C8	CC+220P-C	CERAMIC CAPACITOR	1
C9,10	CC+0.1U25V-C	CERAMIC CAPACITOR	2
C11-14	CC+3P-C	CERAMIC CAPACITOR	4
C15	CP+P1H104JZ	POLYPROPYLENE FILM CAPACITOR	1
C16	CM+V1H224JZT	POLYESTER FILM CAPACITOR	1
C17	CM+V1H474JZT	POLYESTER FILM CAPACITOR	1
C18,19	CP+ECQP1474JZW	POLYPROPYLENE FILM CAPACITOR	2
C20	CC+0.1U25V-C	CERAMIC CAPACITOR	1
C21-23	CC+0.001U-C	CERAMIC CAPACITOR	3
C24-26	CC+0.1U25V-C	CERAMIC CAPACITOR	3
C27	CT+1V010-C	TANTALUM CAPACITOR	1
C28-32	CC+100P-C	CERAMIC CAPACITOR	5
C33-37	CC+0.1U25V-C	CERAMIC CAPACITOR	5
C38	CC+3P-C	CERAMIC CAPACITOR	1
C39-45	CC+0.1U25V-C	CERAMIC CAPACITOR	7
C46	CK+SME25VB330	ALUMINIUM ELECTROLYTIC CAPACITOR	1
C47	CK+SME35VB1000	ALUMINIUM ELECTROLYTIC CAPACITOR	1
C48,49	CC+0.1U25V-C	CERAMIC CAPACITOR	2
C50	CK+SME16VB33	ALUMINIUM ELECTROLYTIC CAPACITOR	1
C51	CC+0.0033U1KV	CERAMIC CAPACITOR	1
C52	CC+0.001U-C	CERAMIC CAPACITOR	1
C53-58	CC+0.1U25V-C	CERAMIC CAPACITOR	6
C59	CC+0.0033U1KV	CERAMIC CAPACITOR	1
D1-5		(not installed)	
D6	DI+1SS97	SCHOTTKY BARRIER DIODE	1
D7	DI+1SS133	SWITCHING DIODE	1
J1	JI+7P-S2T2-EF	CONNECTOR	1
J2	JI+2P-S2T2-EF	CONNECTOR	1
J3	JI+CL581-0113-2	CONNECTOR	1
J4		(not installed)	
J5	JE+0486-01-010	POWER JACK	1
LCD1	ED+HT4096A-TRP1	LCD PANEL	1
NF1-6	NF+EXCCET102U	EMC FILTER	6
NF7,6	NF+ZBF253S-01	FERRITE BEADS	2
Q1-3	QT+FA1L4M-C	NPN TRANSISTOR	3
Q4	QT+FB1L3N-L	NPN TRANSISTOR	1
Q5	QT+C2712Y-C	NPN TRANSISTOR	1
Q6	QT+A1314B-C	PNP TRANSISTOR	1
R1-8	RF+RR277	NETWORK RESISTOR	1
R9-14	RF+RR188A	NETWORK RESISTOR	1
R15,16	RC+1/10W393J	RESISTOR	2
R17	RC+1/10W332J	RESISTOR	1
R18	RC+1/10W822J	RESISTOR	1
R19	RC+1/10W332J	RESISTOR	1
R20	RC+1/10W222J	RESISTOR	1
R21	RC+1/10W102J	RESISTOR	1
R22	RC+1/10W104J	RESISTOR	1
R23	RF+2D4.22KRF	RESISTOR(25PPM/C)	1
R24	RF+2D11.5KQA	RESISTOR(10PPM/C)	1
R25	RC+1/10W104J	RESISTOR	1
R26,27	RC+1/10W332J	RESISTOR	2
R28,29	RC+1/10W393J	RESISTOR	2
R30-34	RC+1/10W101J	RESISTOR	5
R35-38	RC+1/10W103J	RESISTOR	4
R39,40	RC+1/10W473J	RESISTOR	2

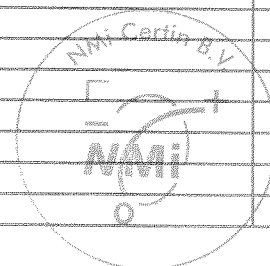

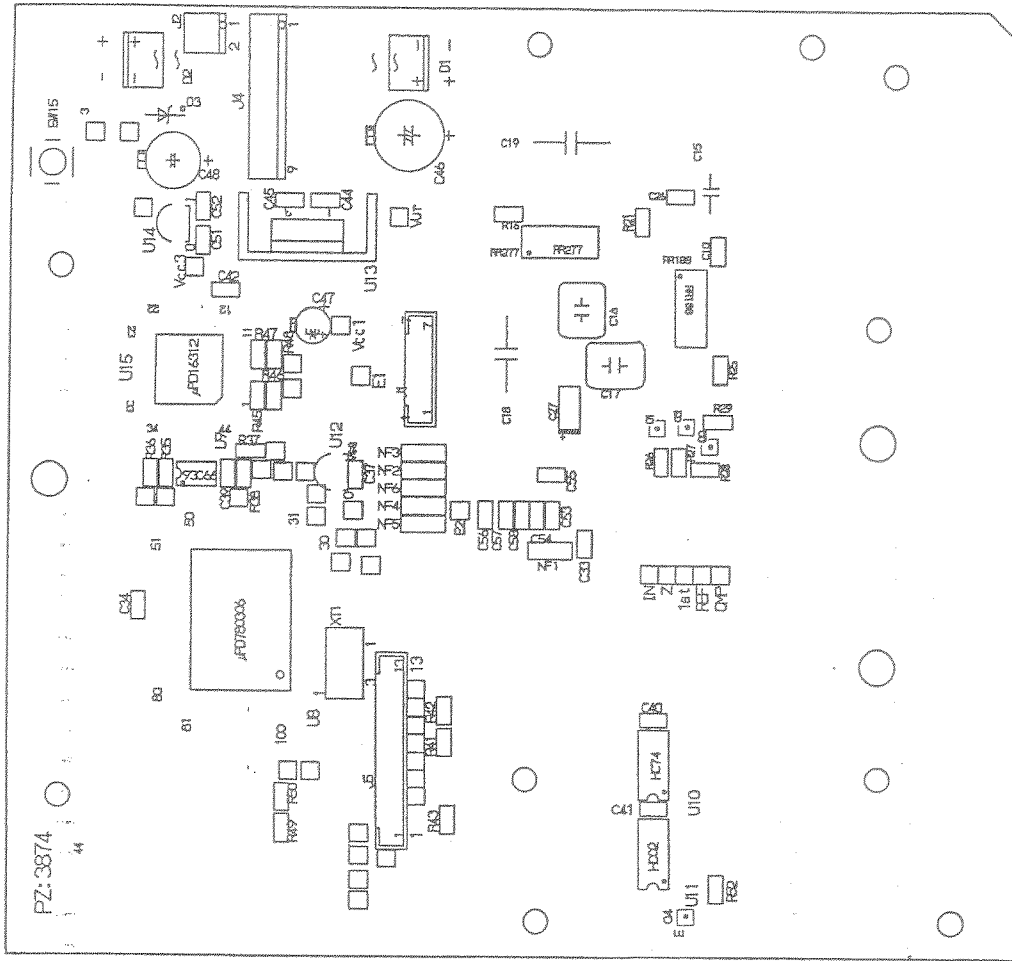
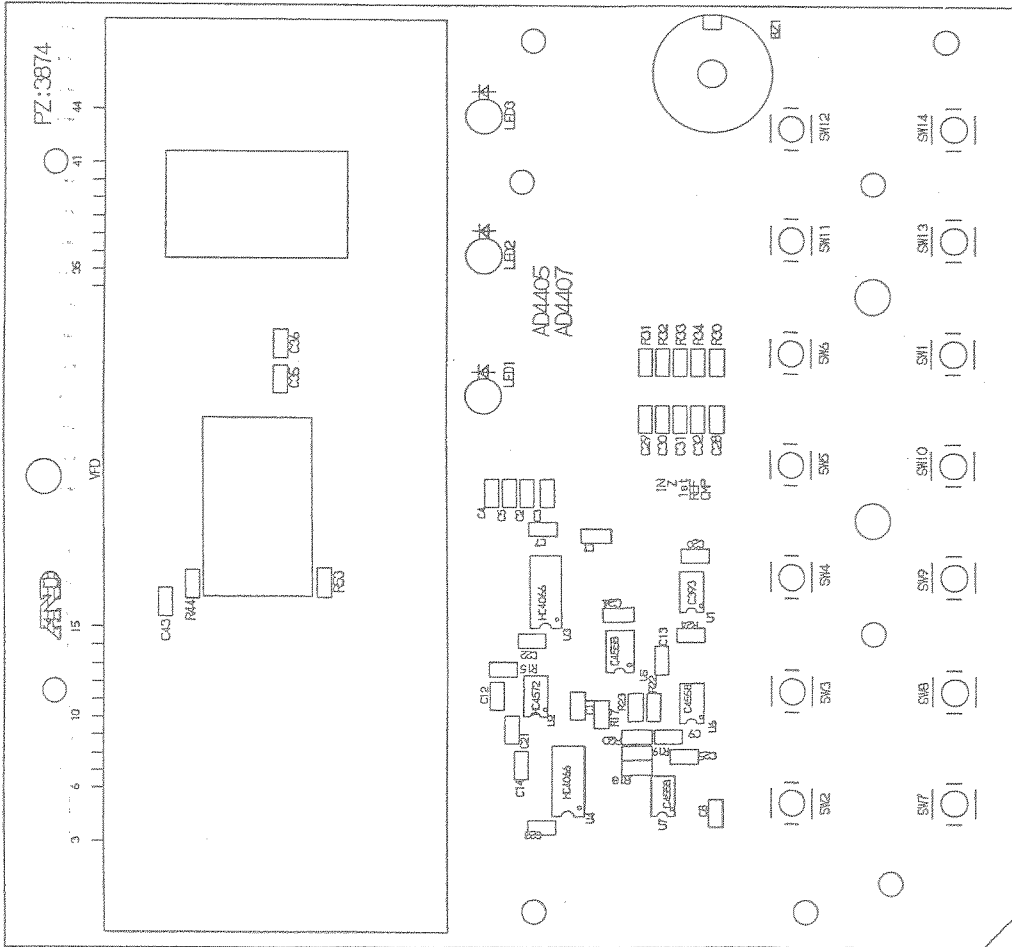

MODEL	AD-4407
DESCRIPTION	MAIN BOARD
STOCK No.	7PZ+3874B 1/3
DRWG.No.	

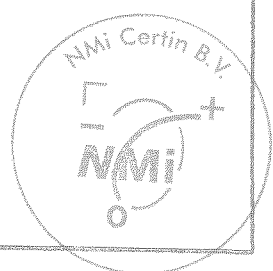

7PZ+3874B PARTS LIST

2/3

Circuit Symbol	Part No.	Description	Quantity
	PC+3874D	PRINTED WIRING BOARD	1
BZ1	ET+EFB-AA40D101	BUZZER	1
C1-5	CC+0.1U25V-C	CERAMIC CAPACITOR	5
C6		(not installed)	
C7	CC+0.1U25V-C	CERAMIC CAPACITOR	1
C8	CC+220P-C	CERAMIC CAPACITOR	1
C9,10	CC+0.1U25V-C	CERAMIC CAPACITOR	2
C11-14	CC+3P-C	CERAMIC CAPACITOR	4
C15	CP+P1H104JZ	POLYPROPYLENE FILM CAPACITOR	1
C16	CM+V1H224JZT	POLYESTER FILM CAPACITOR	1
C17	CM+V1H474JZT	POLYESTER FILM CAPACITOR	1
C18,19	CP+ECQP1474JZW	POLYPROPYLENE FILM CAPACITOR	2
C20	CC+0.1U25V-C	CERAMIC CAPACITOR	1
C21-23	CC+0.001U-C	CERAMIC CAPACITOR	3
C24-26	CC+0.1U25V-C	CERAMIC CAPACITOR	3
C27	CT+1V010-C	TANTALUM CAPACITOR	1
C28-32	CC+100P-C	CERAMIC CAPACITOR	5
C33-37	CC+0.1U25V-C	CERAMIC CAPACITOR	4
C38		(not installed)	
C39-45	CC+0.1U25V-C	CERAMIC CAPACITOR	7
C46	CK+SME35VB1000	ALUMINIUM ELECTROLYTIC CAPACITOR	1
C47	CK+SME16VB33	ALUMINIUM ELECTROLYTIC CAPACITOR	1
C48	CK+SME63VB100	ALUMINIUM ELECTROLYTIC CAPACITOR	1
C49	CC+0.1U25V-C	CERAMIC CAPACITOR	1
C50	CC+5P-C	CERAMIC CAPACITOR	1
C51,52	CC+0.1U25V-C	CERAMIC CAPACITOR	2
C53-58	CC+0.001U-C	CERAMIC CAPACITOR	6
D1,2	DI+1B4B42	BRIDGE DIODE	2
D3	DZ+05Z6.8	ZENER DIODE	1
D4		(not installed)	
D5		(not installed)	
D6		(not installed)	
EB1		(not installed)	
J1	JI+7P-S2T2-EF	CONNECTOR	1
J2	JI+2P-S3T2-E	CONNECTOR	1
J3		(not installed)	
J4	JT+171825-9	CONNECTOR	1
J5	JI+13P-S2T2-EF	CONNECTOR	1
J6		(not installed)	
LED1	DL+GL8HD22	LED(RED)	1
LED2	DL+GL8EG22	LED(GREEN)	1
LED3	DL+GL8HD22	LED(RED)	1
NF1-6	NF+EXCCET102U	EMC FILTER	6
Q1-3	QT+FA1L4M-C	NPN TRANSISTOR	3
Q4	QT+FB1L3N-L	NPN TRANSISTOR	1
R1-8	RF+RR277	NETWORK RESISTOR	1
R9-14	RF+RR188A	NETWORK RESISTOR	1
R15,16	RC+1/10W393J	RESISTOR	2
R17	RC+1/10W332J	RESISTOR	1
R18	RC+1/10W822J	RESISTOR	1
R19	RC+1/10W332J	RESISTOR	1
R20	RC+1/10W222J	RESISTOR	1
R21	RC+1/10W102J	RESISTOR	1
R22	RC+1/10W104J	RESISTOR	1
R23	RF+2D4.22KRF	RESISTOR(25PPM/C)	1
R24	RF+2D11.5KQA	RESISTOR(10PPM/C)	1
R25	RC+1/10W104J	RESISTOR	1
R26,27	RC+1/10W332J	RESISTOR	2
R28,29	RC+1/10W393J	RESISTOR	2
R30-34	RC+1/10W101J	RESISTOR	5

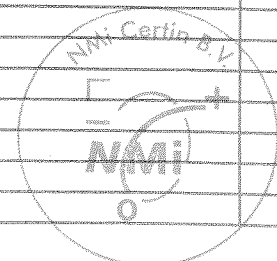

7PZ+3874B PARTS LIST

3/3

Circuit Symbol	Part No.	Description	Quantity
R35-38	RC+1/10W103J	RESISTOR	4
R39,40		(not installed)	
R41-43	RC+1/10W331J	RESISTOR	3
R44	RC+1/10W563J	RESISTOR	1
R45-50	RC+1/10W103J	RESISTOR	6
R51	RC+1/10W222J	RESISTOR	1
R52	RC+1/10W681J	RESISTOR	1
R53	RC+1/10W103J	RESISTOR	1
SW1-15	SK+EVQPAD07K	TACT SWITCH	15
U1	UA+C393G2	COMPARATOR	1
U2	UA+C4572G	OPERATIONAL AMPLIFIER	1
U3,4	UC+HC4066F	QUAD BILATERAL SWITCH	2
U5-7	UA+C4558G2	OPERATIONAL AMPLIFIER	3
U8	UC+D78P0308GF	8-BIT CPU	1
U9	UC+93C66LM8	EEPROM	1
U10	UC+HC74F	DUAL D FLIP-FLOP	1
U11	UC+HC02F	QUAD 2-INPUT NOR GATE	1
U12	UA+S-8054ALR	VOLTAGE COMPARATOR	1
U13	UR+24M05HF	3-TERMINAL VOLTAGE REGULATOR	1
U14	UR+TA78L005AP	3-TERMINAL VOLTAGE REGULATOR	1
U15	UC+D16312GB-3B4	VFD CONTROLLER/DRIVER	1
U16		(not installed)	
VFD	ED+CL1773G	VACUUM FLUORESCENT DISPLAY TUBE	1
XT1	XT+KBR4.91MKSTF	CERAMIC RESONATOR	1
XT2		(not installed)	
	DA+LM-4	LED SPACER	3
	HT+6073PB	HEAT SINK	1
	QA+AC256-1674	COOL SHEET	1
	06+B42081A	VFD PILLOW	2
	04+4006941	SHIELD CASE(A)	1
	04+4006942	SHIELD CASE(B)	1
		M3x8 PAN HEAD SCREW + SPRING WASHER	2
		M3 NUT	2

